

Aufbauanleitung/Assembly Instruction/Instructions d'installation

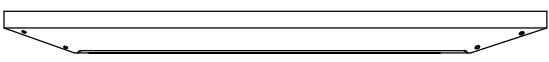

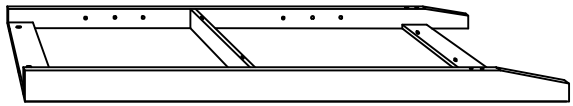

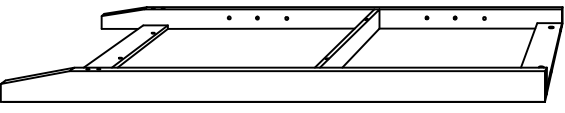

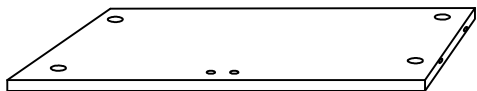
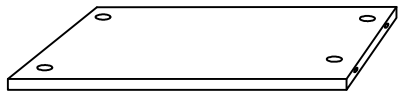
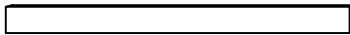
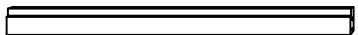
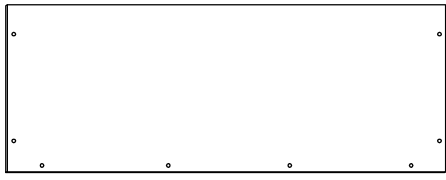
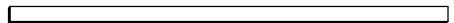
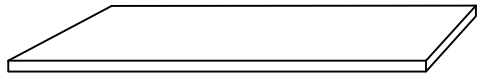
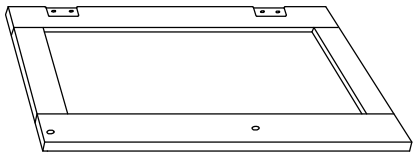
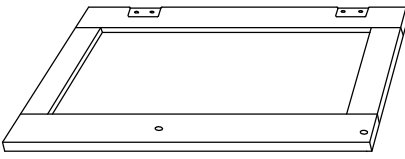
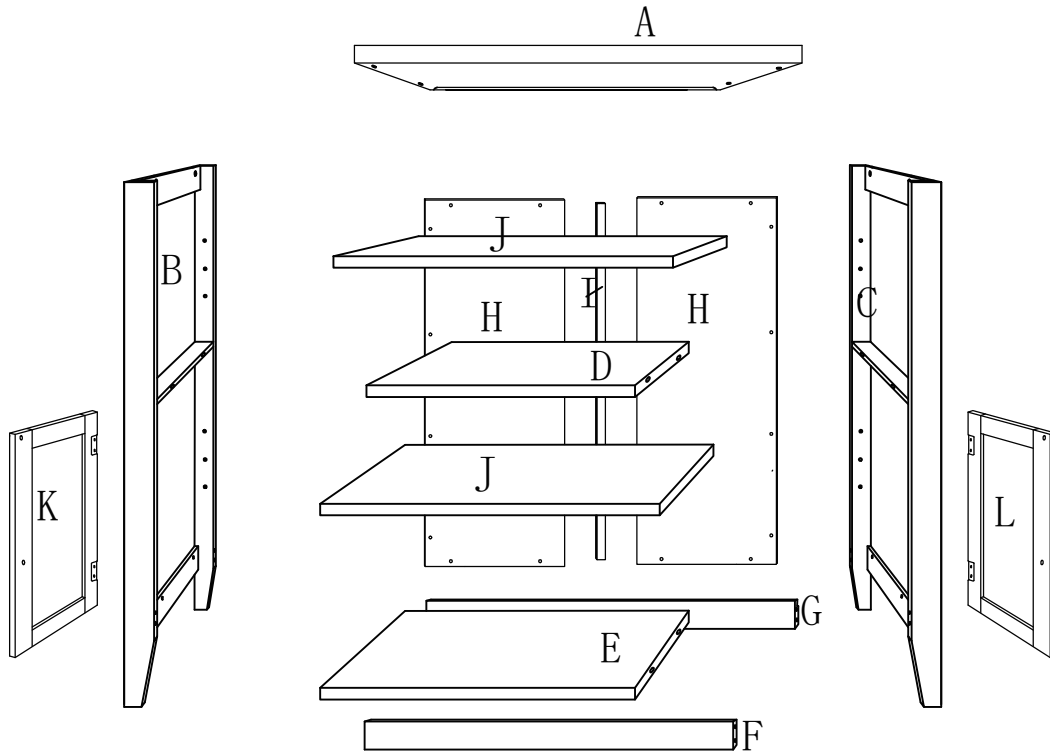

Components

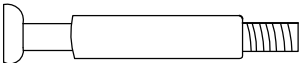
A  × 1PC	B  × 1PC
C  × 1PC	D  × 1PC
E  × 1PC	F  × 1PC
G  × 1PC	H  × 2PCS
I  × 1PC	J  × 2PCS
K  × 1PC	L  × 1PC

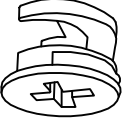

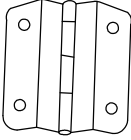
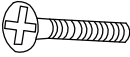

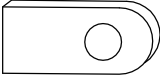

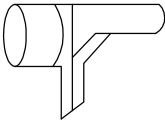
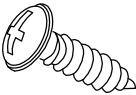
Components



Hardware

1  × 12	2  × 8	3  × 12	4 3 × 12mm  × 20
5  × 4	6 4 × 16mm  × 2	7  × 2	8  × 2
9  × 1	10  × 8	11 3 × 12mm  × 16	

STEP 1

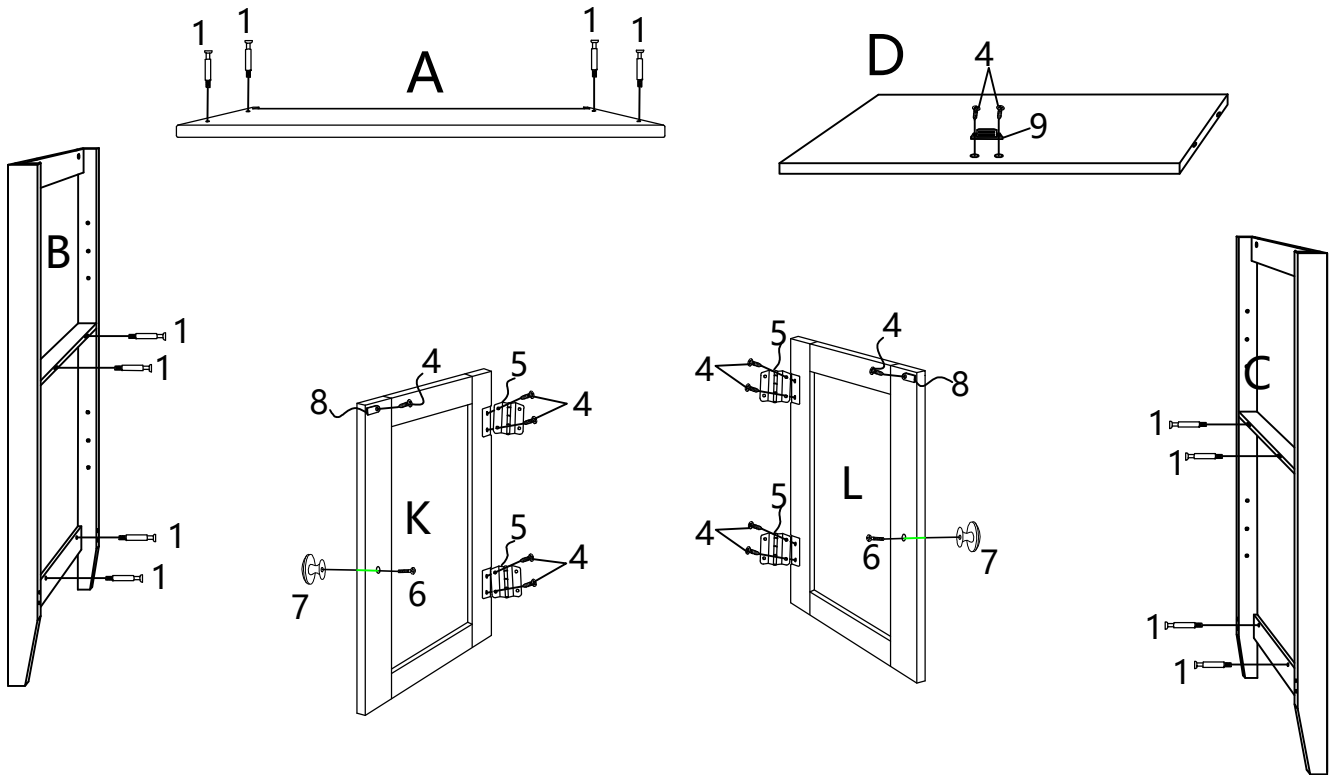

	1×12		4×12		5×4		6×2
	7×2		8×2		9×1		





STEP 2

	3×4
---	-----

STEP 3

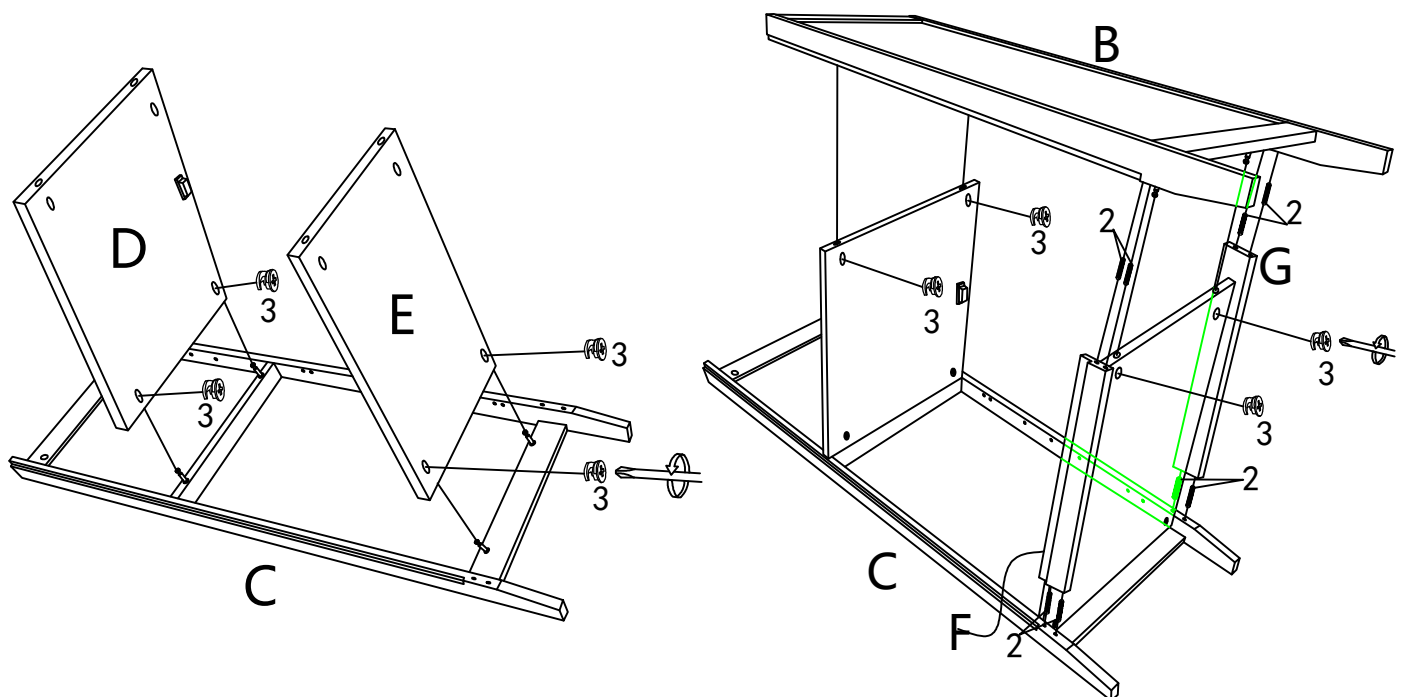
	2×8		3×4
--	-----	---	-----



STEP 4  3×4

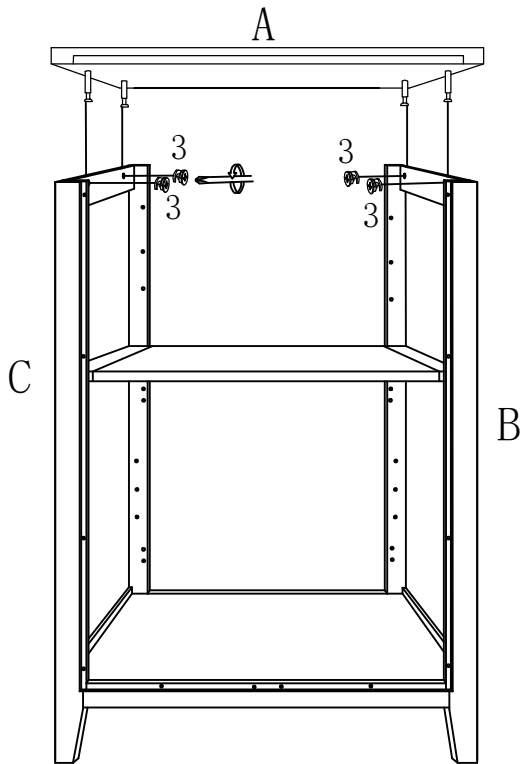

STEP 5

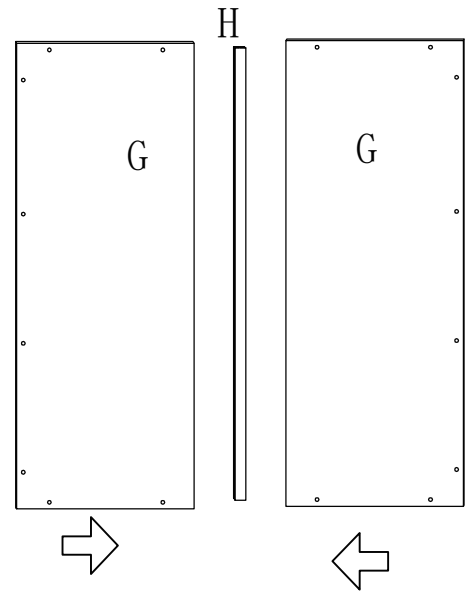

STEP 6  11×16

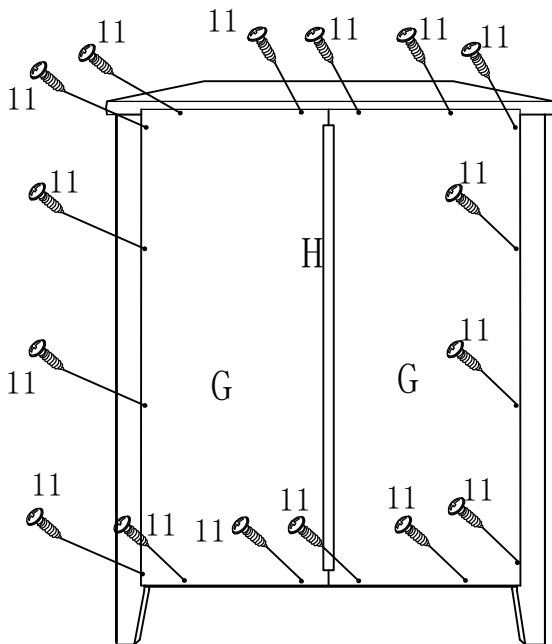

STEP 7  4×8

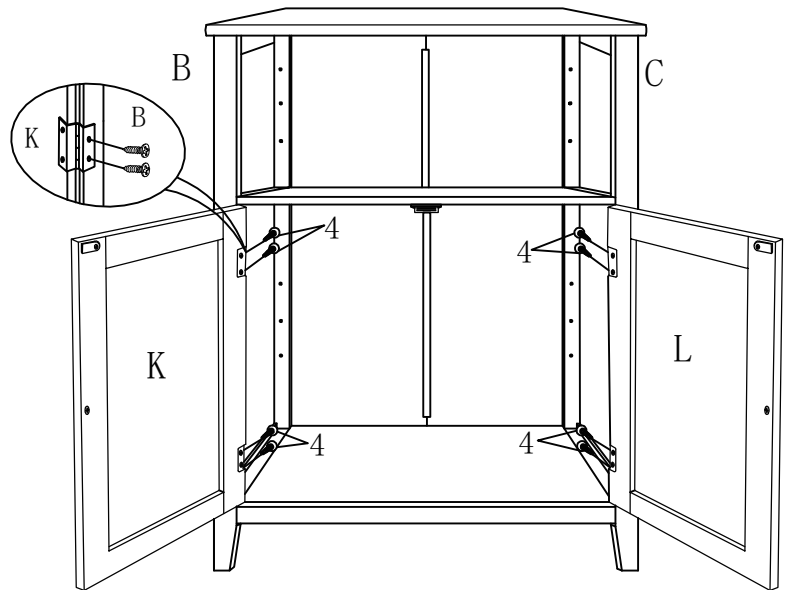

STEP 8

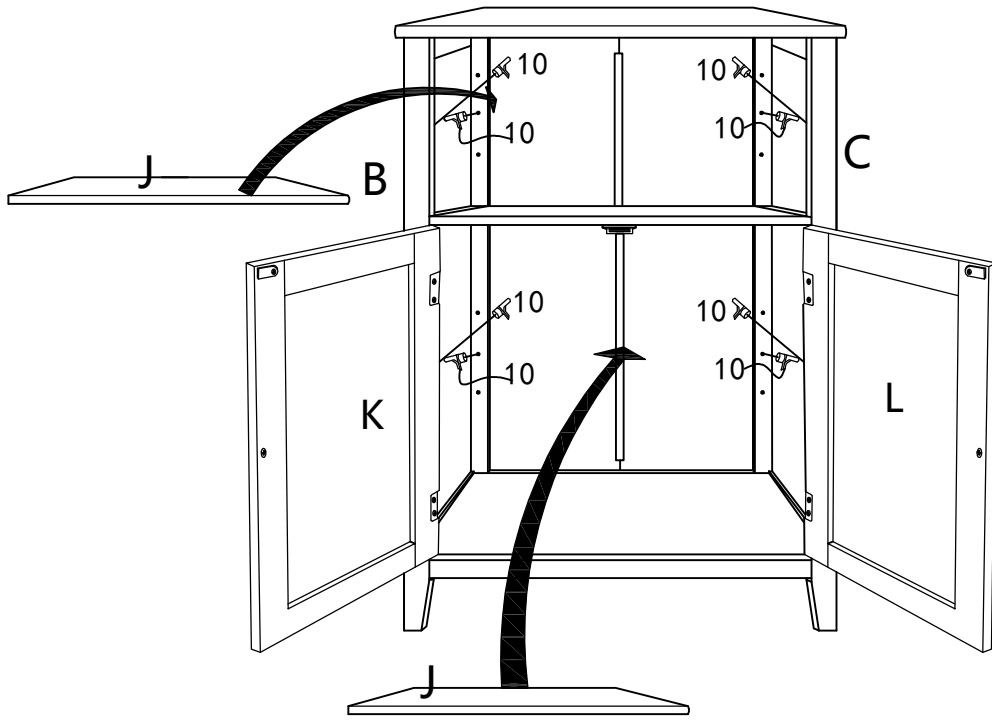
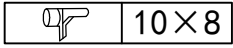

STEP 9

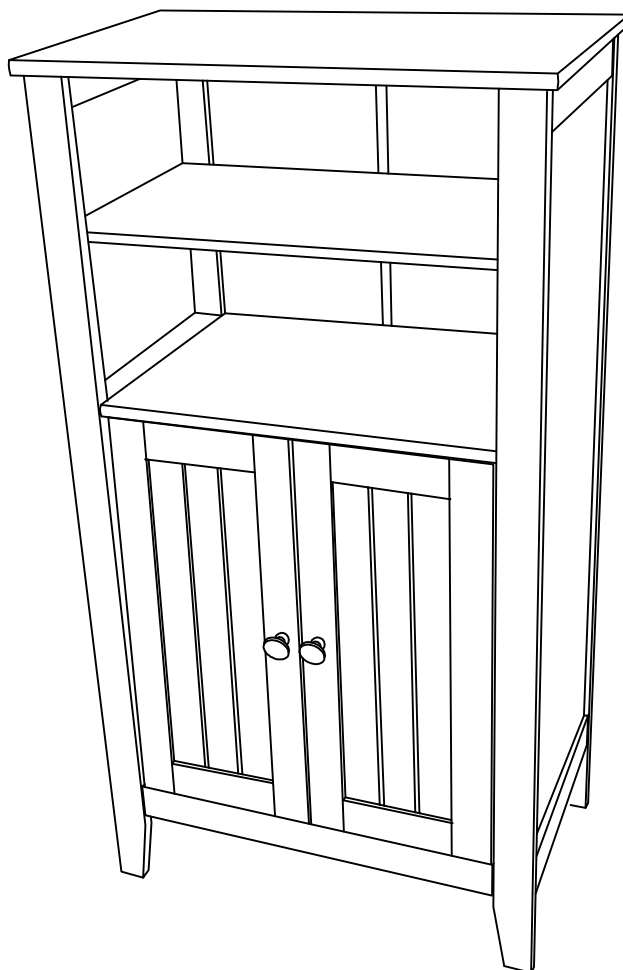

▲ Kundendienst

Bitte wenden Sie sich bei Problemen an unser Kundenservice-Team und einfach über das Käuferportal unter "Verkäufer kontaktieren" mit uns in Kontakt treten oder senden Sie uns eine E-Mail als B2C-Kunde.

▲ services après vente

Si vous avez des questions n'importe quoi, veuillez vous sélectionner "contactez le vendeur" directement sur la page de l'acheteur pour contacter notre équipe du service de la clientèle ou par courriel à notre équipe du service de la clientèle de B2C!

▲ Customer service

If you have any problems, please contact our Customer Service team directly via the Buyer Page "contact seller" or send emails to our B2C customer service.

▲ servizio di assistenza

Se avete problemi, potete contattarci nella pagina dell'acquirente via "Contatta il venditore" o inviare e-mail al nostro servizio clienti B2C.

▲ servicio post-venta

Si tiene algún problema, comuníquese con nuestro equipo de servicio al cliente y simplemente contáctenos a través del Portal del Comprador en "contacto con el vendedor" , o envíe un correo electrónico a nuestro equipo de servicio al cliente B2C!